

*Technologies, Computer Engineering and Science (ICATCES'18)*, pp.11-13, Safranbolu, Turkey, May 2018.

**3-** A. Kamran, H. Shah and P. Kingston, "RFID applications: An introductory and exploratory study," *IJCSI International Journal of Computer Science Issues*, Vol. 7, Issue 1, No. 3, January 2010.

**4-** D. Parkash, T. K., and K. Preet. "The RFID technology and its applications: A review." *International Journal of Electronics, Communication & Instrumentation Engineering Research and Development*, pp. 111-113, 2012.

**5-** S. Alyahya, Q. Wang, and N. Bennett. "Application and integration of an RFID-enabled warehousing management system—a feasibility study." *Journal of Industrial Information Integration* 4 (2016): 15-25.

**6-** M. H. Eldefrawy and M. K. Khan, "Banknote Validation through an Embedded RFID Chip and an NFC-Enabled Smartphone," Hindawi Publishing Corporation, *Mathematical Problems in Engineering*, vol. 2015, Article ID 264514, 8 pages, 2015.

**7-** A. Vena, E. Perret, S. Tedjini, G. Eymin P. Tourtollet, A. Delattre, F. Garet, and Y. Boutant. "Design of chipless RFID tags printed on paper by flexography." *IEEE Transactions on Antennas and Propagation* 61, no. 12 (2013): 5868-5877.

**8-** Herrojo, Cristian, Miquel Moras, Ferran Paredes, Alba Núñez, Eloi Ramon, Javier Mata-Contreras, and Ferran Martín. "Very low-cost 80-bit chipless-RFID tags inkjet printed on ordinary paper" *Technologies* vol. 6, No. 2, pp. 52, 2018

**9-** B. Waris, L. Ukkonen, J. Virkki, T. Björninen, "Wearable Passive UHF RFID Tag based on a Split Ring Antenna," *IEEE Radio and Wireless Symposium (RWS)*, 2017.

**10-**S. López-Soriano and J. Parrón, "Wearable RFID tag antenna for healthcare applications," IEEE-APS Topical Conference on Antennas and Propagation in Wireless Communications (APWC), Turin, Italy, pp. 7-11, October 2015

**11-**I. Jabeen, A. Ejaz, S. M. Kabir, A. Akram, Y. Amin, and H. Tenhunen. "Octagonal shaped flexible chipless RFID tag for Internet of Things." *International Conference on Electrical, Communication, and Computer Engineering (ICECCE)*, pp. 1-4. 2019.

**12-**O. Boularess, L. Ladhar, A. A., and S. Tedjini. "Analysis of RCS signatures of chipless RFID tags based on Arabic alphabet letters with punctuation." *Applied Computational Electromagnetics Society Journal*, vol.34, no. 5 (2019).

**13-**V. Sharma, S. Malhotra, and M. Hashmi. "Slot resonator based novel orientation independent chipless RFID tag configurations." *IEEE Sensors Journal* vol.19, no. 13 pp. 5153-5160, 2019

**14-**S. Preradovic, I. Balbin, N. C. Karmakar and G. Swiegers, "A novel chipless RFID system based on planar multiresonators for barcode replacement" *IEEE International Conference on RFID*, The Venetian, Las Vegas, Nevada, USA, April 2008.

**15-**D. Laila1, R. Thomas, C. M. Nijas, and P Mohanan "A Novel Polarization Independent Chipless RFID Tag Using Multiple Resonators" *Progress In Electromagnetics Research Letters*, Vol. 55, pp. 61–66, 2015.

**16-**N. C. Karmakar, R. Koswatta, P. Kalansuriya, and E. Rubayet, *Chipless RFID reader architecture*. Artech House, 2013.

**17-**N. C. Karmakar, E. Md Amin, and J. K. Saha. "Chipless RFID sensors." John Wiley & Sons (2016).

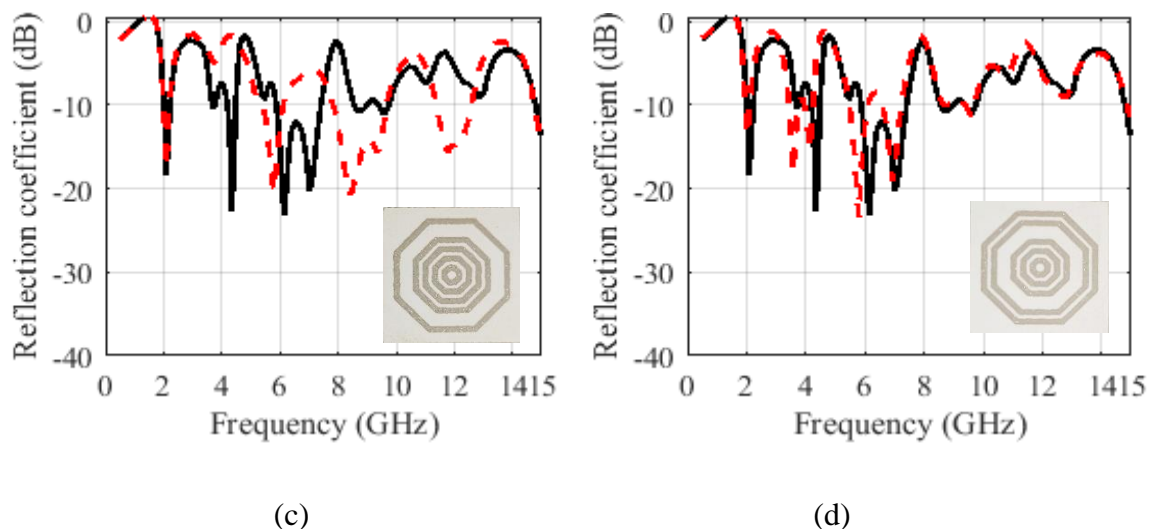

Figure 27. Reflection coefficient of the reader antenna for different concentric octal rings field RFID tag configurations printed on paper.

#### IV. Conclusion

1. The experiment of Preparation of Electrically Conductive Silver Ink for Silk-Screen Printing for Identification Applications with wideband antenna is used as a near field reader for the designed RFID tags.
2. The effect of the tag appears as resonance frequencies due to the presence of the conducting patch and the additional substrate of the antenna.
3. The effective dielectric constant of the RFID tag is increased.
4. Two different design of RFID tags are designed in this experiment; the designs are concentric square rings and concentric octal rings. All proposed RFID tags consist of concentric rings printed on a dielectric slab.
5. Two dielectric slabs are used, Egyptian banknote and paper.
6. That Possibility of manufacturing and preparing high quality locally produced for conductive inks with medium electrical resistance that we can use to print Chipless RFID tags.
7. Preparing and depositing the conductive silver particles is relatively of lower cost than conductive silver that is imported from abroad.
8. The resistance of the conducting silver inks is in a low area, where the electrical resistance is between (3-10) ohm/cm.
9. The advantage of these simples' configurations is that it has a significant difference more than 10 dB in the reflection coefficient between the presence and the absence of the corresponding ring resonator, this significant difference can be easily detected by a simple wideband receiver system.

#### V. References

- 1- K. Finkenzer, RFID Handbook, 2nd Edition, John Wiley & Sons, Ltd., 2003.
- 2- S. ERSÖZ, A. F. İNAL, A. AKTEPE, A. K. TÜRKER, "A literature review on RFID applications in advanced manufacturing systems," *International Conference on Advanced*

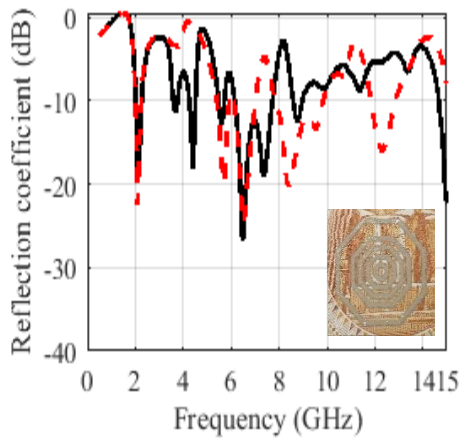

(c)

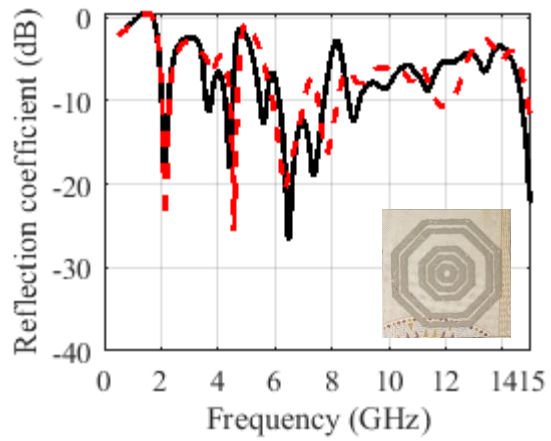

(d)

Figure 25. Reflection coefficient of the reader antenna for different concentric octal rings field RFID tag configurations printed on Egyptian banknote.



Figure 26. Near field RFID tag identification printed on paper by using a wideband antenna

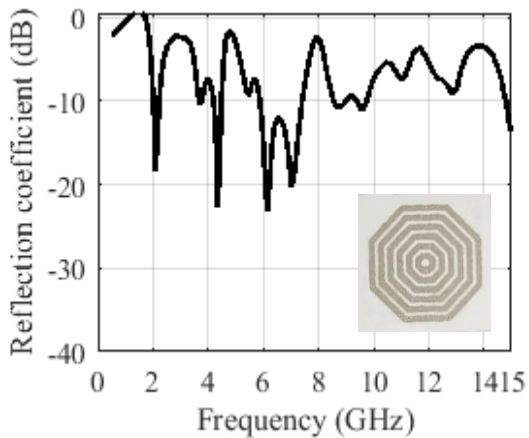

(a)

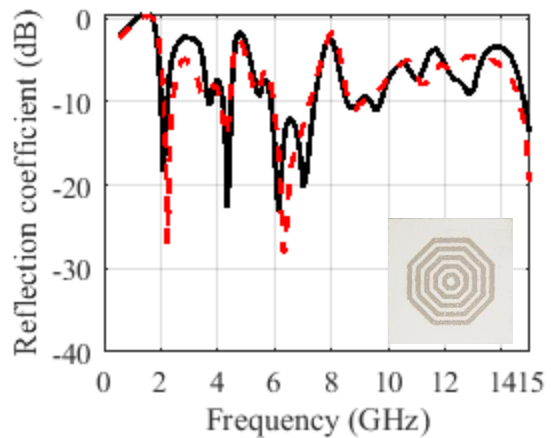

(b)

archived are 2.095, 4.343, 6.155, 8.838, 9.563, 12.9, and 15 GHz. RFID tag resonances are 2.24, 4.343, 8.838, and 15 GHz as shown in Fig. 27b. Figure 27c shows the resonances at 2.095, 5.793, 8.402, 11.96, and 15 GHz. Figure 27d shows RFID tag resonances, 2.03, 3.545, 5.793, 6.952, 12.82, and 15 GHz.

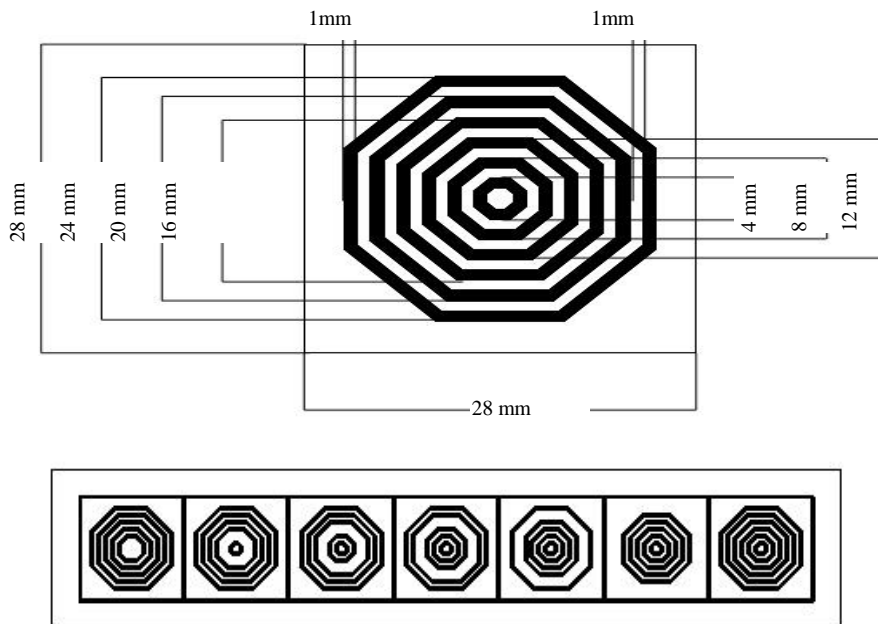

Figure 23. concentric octal rings field RFID tag and different configurations.

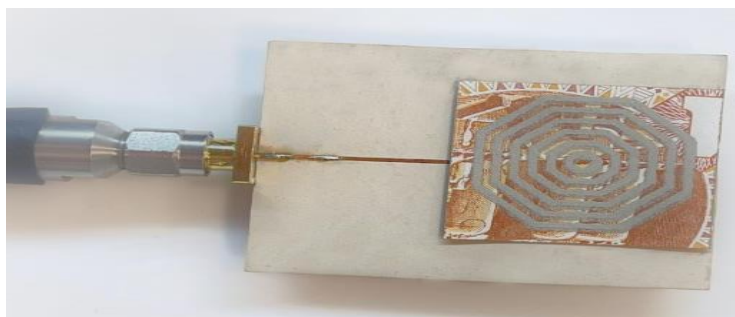
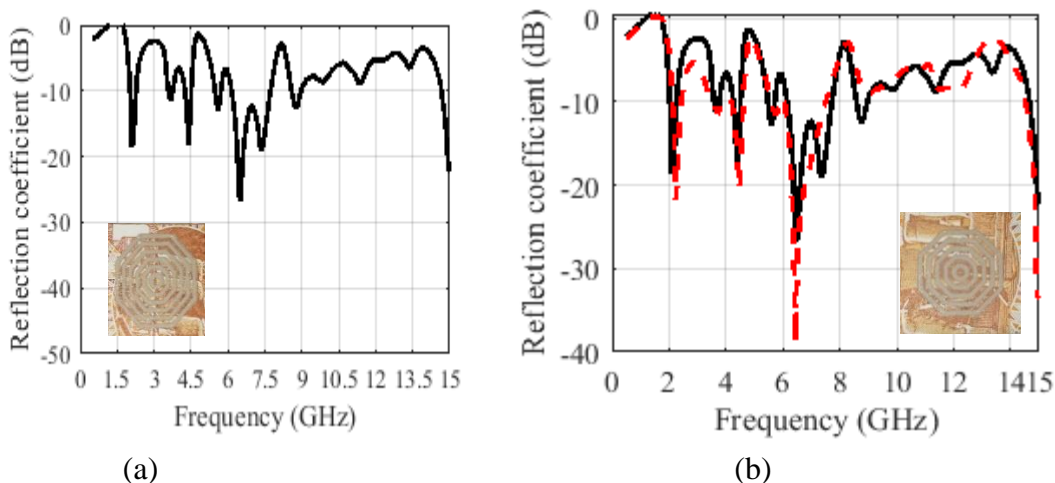

Figure 24. Near field RFID tag identification printed on Egyptian banknote by using a wideband antenna



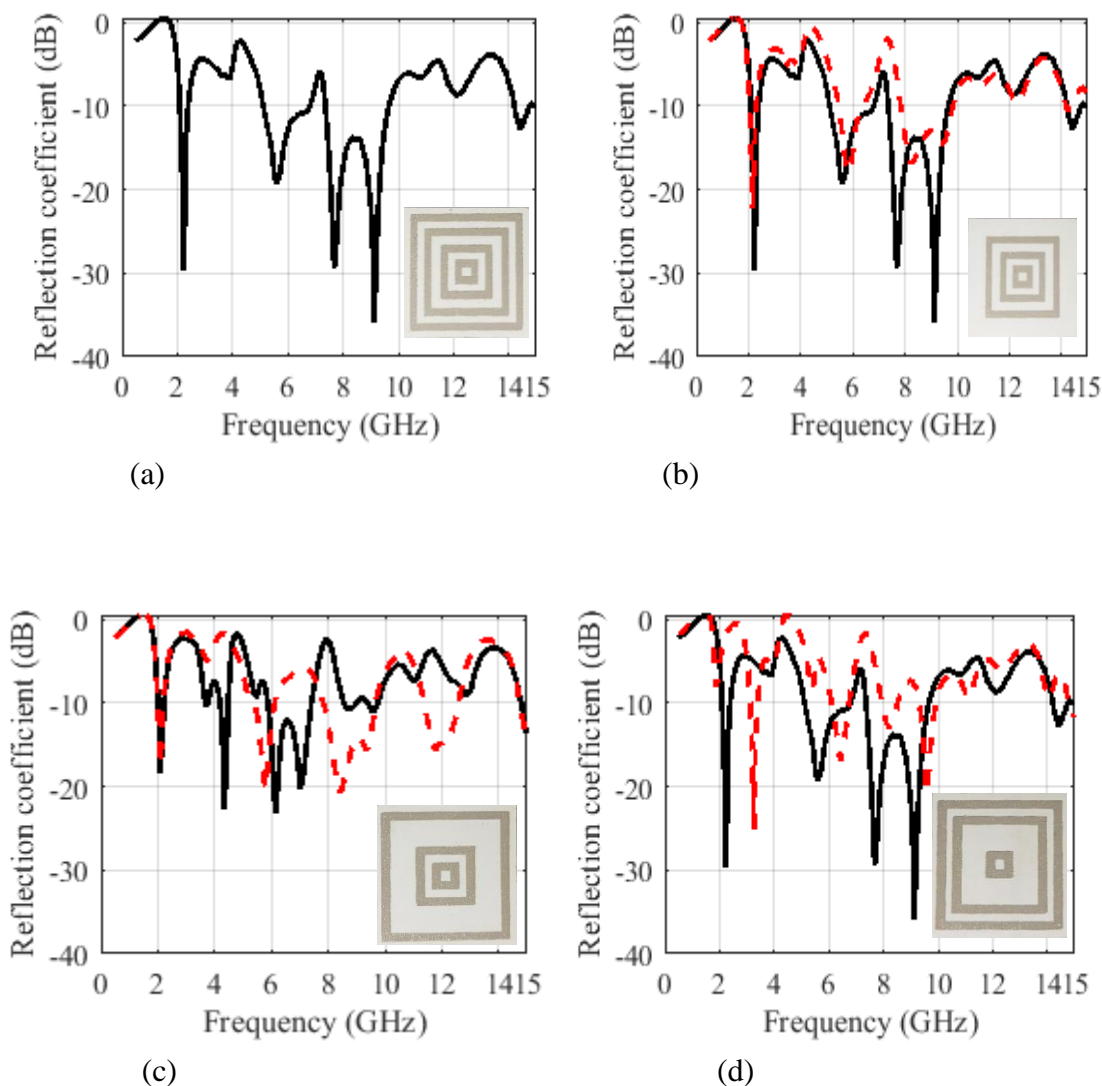

Figure 22. Reflection coefficient of the reader antenna for different concentric square rings field RFID tag configurations printed on paper.

### B. Concentric octal Rings Passive RFID Tag

Figure 23 shows the design of the concentric octal rings field RFID tag. All dimensions of the concentric octal rings field RFID tag are shown in Fig 23. As pervious section, RFID tags are printed on two different substrates, Egyptian banknote and paper. Near field RFID tag identification printed on Egyptian banknote by using a wideband antenna is shown in Fig 24. Resonances achieves from the RFID tag printed on the Egyptian banknote are shown in Fig 25. Figure 25a RFID resonances are 2.095, 4.415, 6.518, 7.388, 8.765, and 15 GHz. Resonance for remove ring in RFID tag are 2.24, 4.487, 6.445, 8.982, and 15 GHz. The resonances are 2.095, 5.72, 6.518, 8.402, and 12.32 GHz in Fig. 25c. Figure 25d shows the RFID resonances at 2.168, 4.56, 6.372, 7.822, 11.88, and 15 GHz. The previous section is repeated with changing the substrate to paper and printing the RFID tags on it. Near field RFID tag identification printed on paper by using a wideband antenna are shown in Fig 26, Figure 27a. the RFID tag resonance

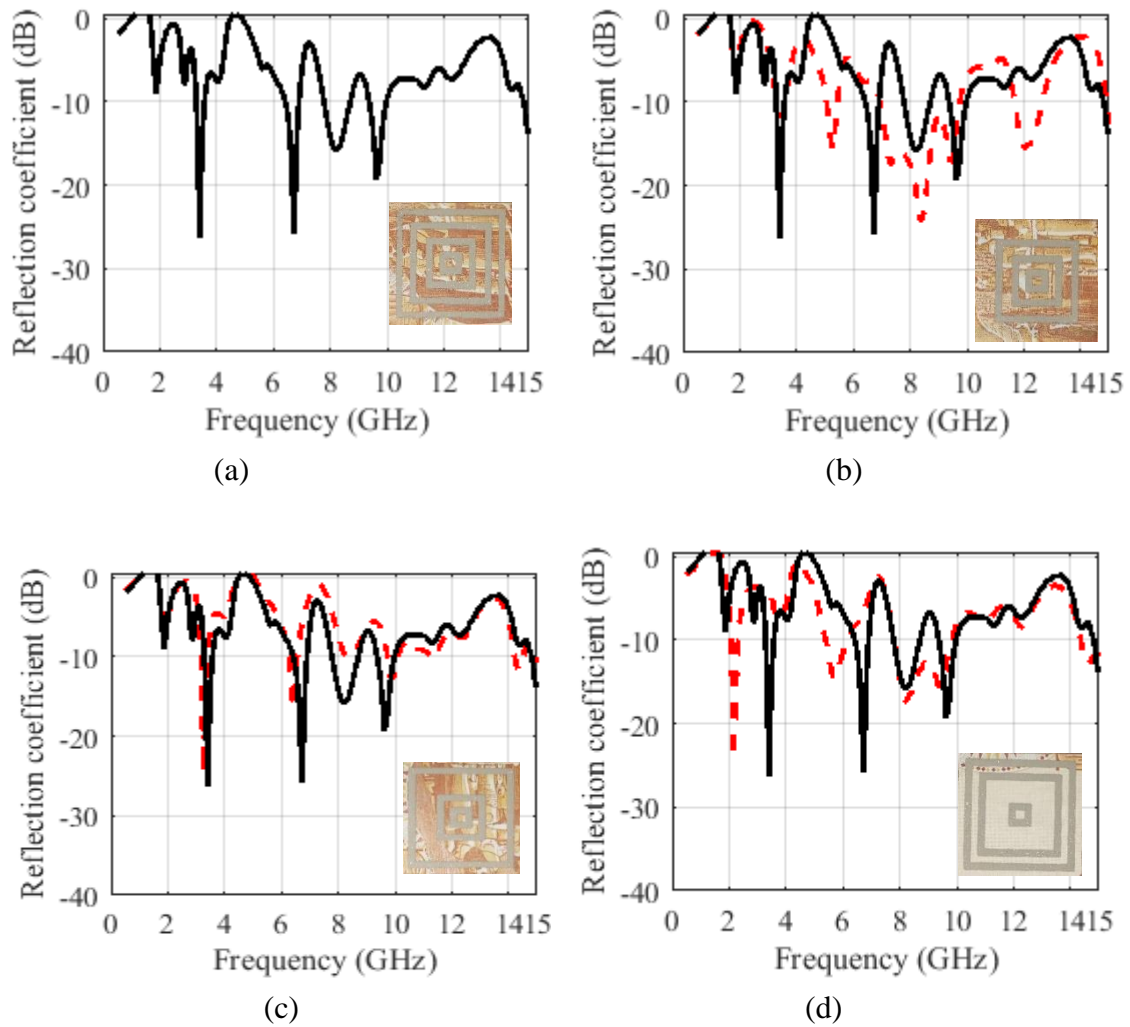

Figure 20. Reflection coefficient of the reader antenna for different concentric square rings field RFID tag configurations printed on Egyptian banknote.

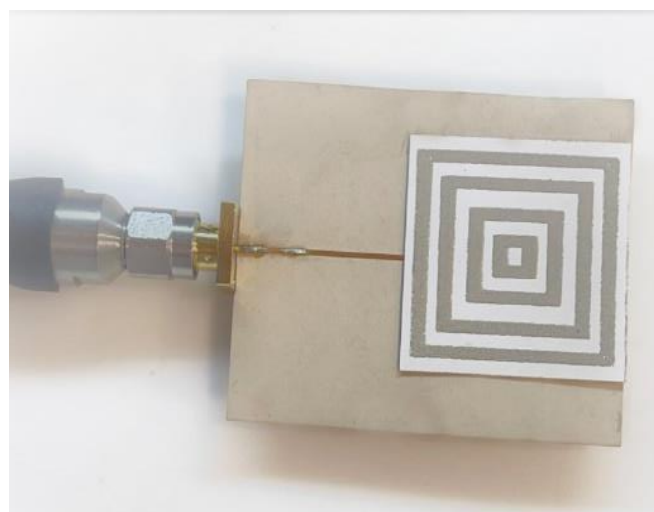

Figure 21. Near field RFID tag identification printed on paper by using a wideband antenna

The advantage of this simple configuration is that it has a significant difference more than 10dB in the reflection coefficient between the presence and the absence of the corresponding ring resonator. This significant difference can be easily detected by a simple wideband receiver system.

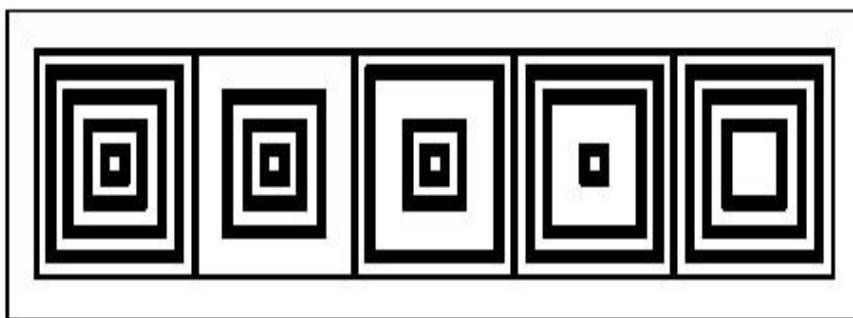
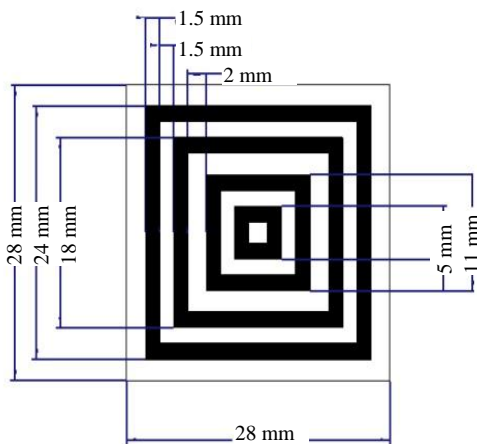

Figure18. Concentric square rings field RFID tag and different configurations.

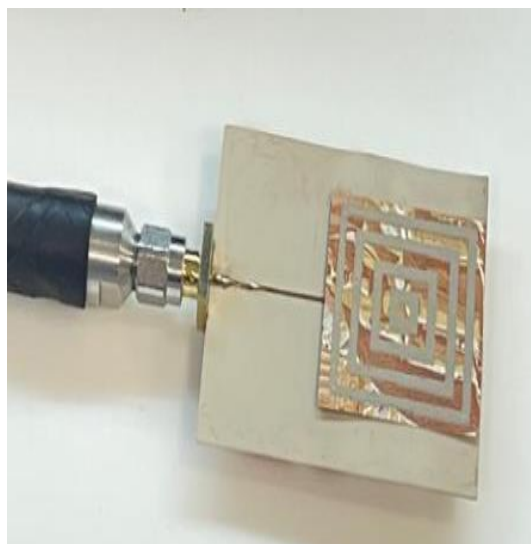
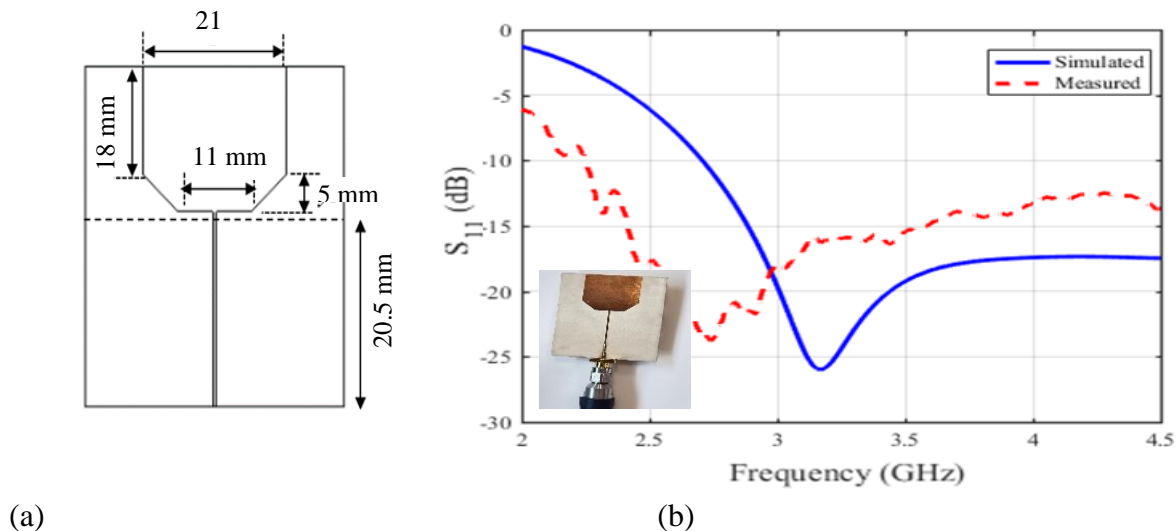

Figure19. Near field RFID tag identification printed on Egyptian banknote by using a wideband antenna.





(a) (b)  
**Figure17. (a) Geometry of the Reader antenna and (b) Simulated and measured  $S_{11}$  of the reader antenna**

This wideband antenna is used as a near-field reader for the designed RFID tags. The effect of the tag appears as resonance frequencies. Due to the presence of the conducting patch and the additional substrate of the antenna, the effective dielectric constant of the RFID tag is increased, two different designs of RFID tags are designed in this section. The designs are concentric square rings, and concentric octal rings. All proposed RFID tags consist of concentric rings printed on a dielectric slab, two dielectric slabs are used, Egyptian banknote and paper.

### A. Concentric Square Rings Passive RFID Tag

Figure. 18 shows the design of the concentric square rings RFID tag. The width of each ring is 1.5 mm and the spacing between successive rings is also 1.5 mm. The outer length of the greatest ring is 24 mm while the length of the substrate is 28 mm. All dimensions are shown in Fig 18, the RFID tags are prepared with silver ink and printed on an Egyptian banknote substrate. Figure 19 shows the near field concentric square rings RFID tag identification by using a wideband antenna. Figure 20 shows measure reflection coefficients of the reader antenna for different concentric square rings field RFID tag printed on Egyptian banknote.

The RFID tag has resonances at 1.877, 2.893, 3.4, 6.735, 8.185, 9.707, and 15 GHz as shown in Fig 20a, Figure 20b shows the RFID resonance at 1.877, 3.545, 5.213, 7.315, 8.402, 9.418, 12.03, and 15 GHz. The resonance in fig. 20c is 1.877, 3.255, 6.445, 8.402, 9.925, 11.3, 15 GHz. In Fig. 20d shows resonances at 2.168, 3.69, 5.72, 8.185, 9.49, 11.01, 12.32, 15 GHz. It can be seen that the effect of removing rings on the resonances of the reader antenna. It is quite clear that each ring corresponds to a specific resonance frequency which can be classified as digital bit in the corresponding RFID tag. Based on these results, it can be concluded that this multi-ring resonator structure can be used as RFID tag for a near field RFID system.

In this section we printed the RFID tags on a paper substrate. The resonances for full Concentric square rings are 2.24, 5.575, 7.678, 9.127, 12.1, and 14.42 GHz as shown in Fig 22a, by removing rings, the resonance is changed. Figure 22b shows the RFID resonances at 2.168, 5.793, 8.258, 9.418, 12.32, and 14.28 GHz. The resonances are 1.59, 3.545, 4.955, 7.388, 8.457, 9.345, and 11.23 GHz as shown in Fig 22c. Figure 22d shows resonances at 1.877, 3.255, 6.455, 8.258, 9.563, and 15 GHz.



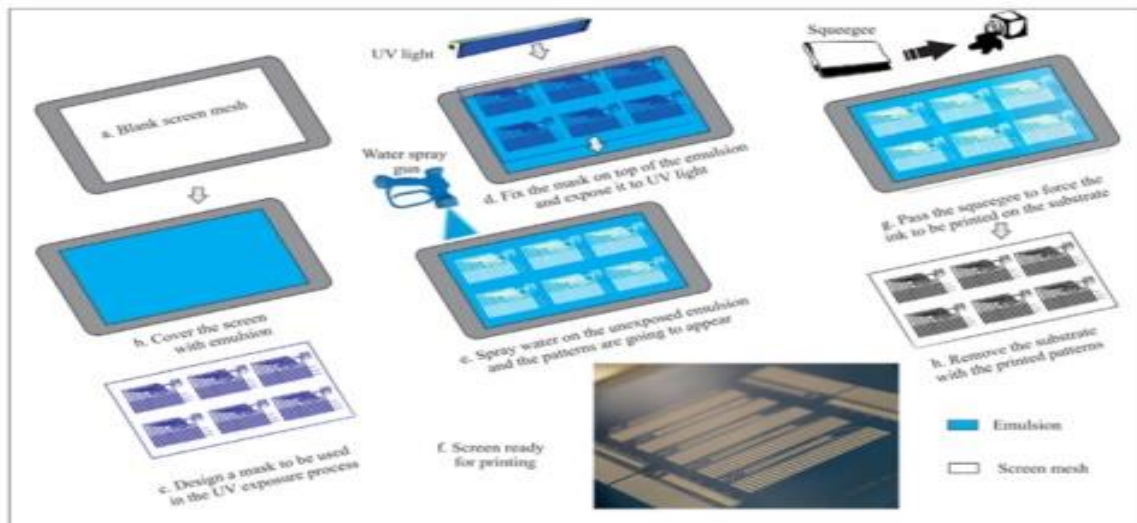

Figure15. Demonstrates the steps required for patterning the electrode design on the screen

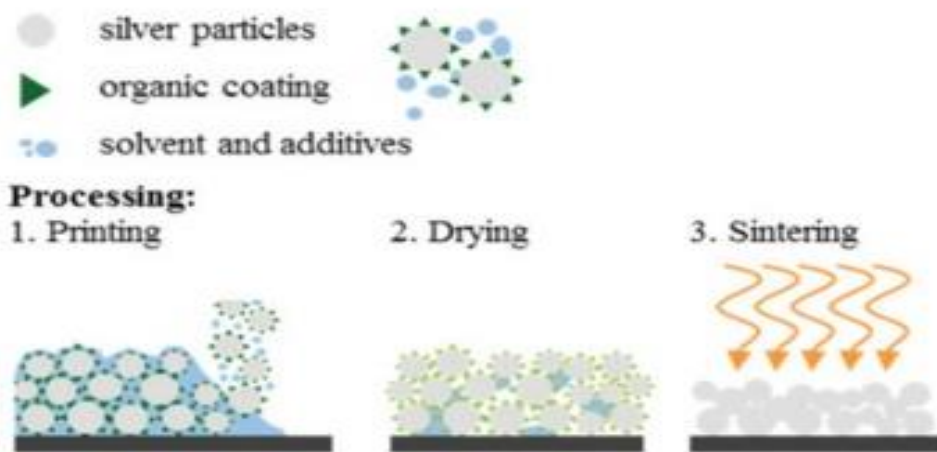

Figure16.process steps to achieve conductive layers consisting of silver nanoparticle inks

### III. Design of A Wide band antenna as RFID Reader

In this section, near-field identification is proposed by using a wideband antenna as a reader. Figure 17a shows the geometry of the proposed wideband antenna. It consists of a partially grounded patch with a tapered section to be matched with a 50 Ω microstrip line. The antenna is printed on a substrate RO3003 of thickness 0.25 mm. The overall size of the antenna is 38×41mm<sup>2</sup>. Figure 17b shows the reflection coefficient of the wideband antenna. It can be seen that this antenna has a reflection coefficient of less than -10 dB in the frequency range from 2.2 to 4.5 GHz.

## 2. Afterwards, sintering is performed during sintering, three main steps may happen:

- Organic solvent combustion and burn out (low temperatures  $< 300^{\circ}\text{C}$ ).
- Possibility of oxidation/reduction of the metallic elements.
- Sintering of the conductive metallic elements and inorganic binder in order to ensure Conductive film adhesion to the substrate.
- The sintering process depends on temperature, process duration and atmosphere which the resistance reduces to (3-10) Ohm/square, when sintering was performed at  $300^{\circ}\text{C}$  for 15 min.



Figure13. Chipless RFID tag

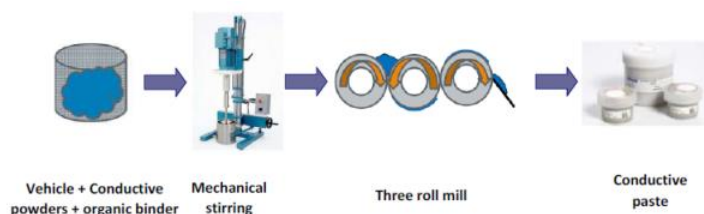

Figure14. Screen printing conductive ink formulation processing

## 5. Screen printing:

The steps that are required for patterning the electrode design on the screen are demonstrated as follows:

1. A blank stainless-steel screen is stretched on a surrounding frame with a defined tension.
2. The emulsion is deposited on the screen to cover it completely, and the screen is left to dry. A transparent mask is designed and printed according to the electrode patterns.
3. The mask is fixed on the emulsion side of the screen and it is exposed to ultraviolet light.
4. The screen is water sprayed to remove the unexposed emulsion; the removed emulsion leaves uncovered pores where the ink can pass through them.
5. To deposit the screen-printing ink through the mesh, complete contact should occur between the screen and the substrate where the ink is deposited, this is done when the squeegee pushes the screen directly on the substrate, and the emulsion blocks the excess ink.
6. The emulsion exposure process required for processing the patterns on the screen can be done by several techniques, some emulsions require ultraviolet light to be fully exposed, and other emulsions can be exposed using sunlight only.
7. The total time required for preparing the patterns on the screen is approximately 20 mins.
8. The screens are fabricated either from polyester or stainless steel, Polyester screens are flexible and resilient, but they are more prone to absorb moisture and swelling. The stainless-steel screens are stronger and can handle more abrasion with reduced swelling which can help in increasing the lifetime. In addition, several screen-printing parameters mentioned above can affect the lifetime of the screen.



Figure9. Screen printing inks

**2. Powders (conductive particles) are progressively added.**



Figure10. Powders (conductive particles)

**3. Mechanical mixing is performed to ensure powder dispersibility in the vehicle.**



Figure11. Mechanical mixing and conductive silver paste

**4. Sintering**

1. After film deposition, leveling takes place which enhances film homogenization. Then, printed patterns are dried, the organic vehicle is evaporated and burnt out, infra-red drying of silver particles dispersed in terpineol at 140°C, 13.7 Ohm/square sheet resistance was obtained.



Figure12. Hot air gun



Figure5. the cathode just starts to bubble hydrogen

4. Magnetic stirring and a stir bar should be applied to constantly shred the silver dendrites as they grow.



Figure6. The silver dendrites are growing.

5. Eventually, the anode will be consumed and the solution is decanted to recover the silver powder.



Figure7. The silver

powders

6. The silver powder is washed a few times with water and then dried by heating on the hot plate



Figure8. Whatman 54 filter paper

### 3. Mixture

1. The ink vehicle is prepared by Pachin Company and we use special kinds of silk screen printing, in this study we focus only on (Pachin S47) pastes used for commercial silk screen printing.





**Figure2. Solution of 1g silver nitrate in 50 ml water**

**1.** Submerge an anode made of pure silver (I'm using silver coins) and a cathode of carbon.



**Figure3. Pure silver**

**2.** Connect the anode (silver) to the positive terminal of a variable power supply and connect the cathode (carbon) to the negative terminal.



**Figure4. Connect the anode (silver) and the cathode (carbon)**

**3.** Apply a current and raise it until the cathode just starts to bubble hydrogen and then lower it by about 25%.

For example, terephthalic acids react with bismuth oxides, and then paste viscosity is enhanced over time. Ethylcellulose, acrylic, and styrene acrylic polymers, polyesters, and other polymers can be used as binders.

### 1.1.3 Additives

-Theological agents: are used to modify viscosity and to guarantee ink-specific theological behavior such as pseudo-plasticity and thixotropy. Besides, surfactants are added to enhance dispersion stability by creating stories or electrostatic stabilization to prevent particle agglomeration.

-A wetting agent: can be used to adjust the surface tension of the ink and induce substrate wetting.

- Antifoaming agents: can be used to avoid foam formation in the water-based inks, because bubble foams generate voids in the conductive lines during printing.

## 2. Experimental processing of Conductive pastes

To control the properties of a conductive film, particles, pastes, and sintering processing should be understood figure 1.

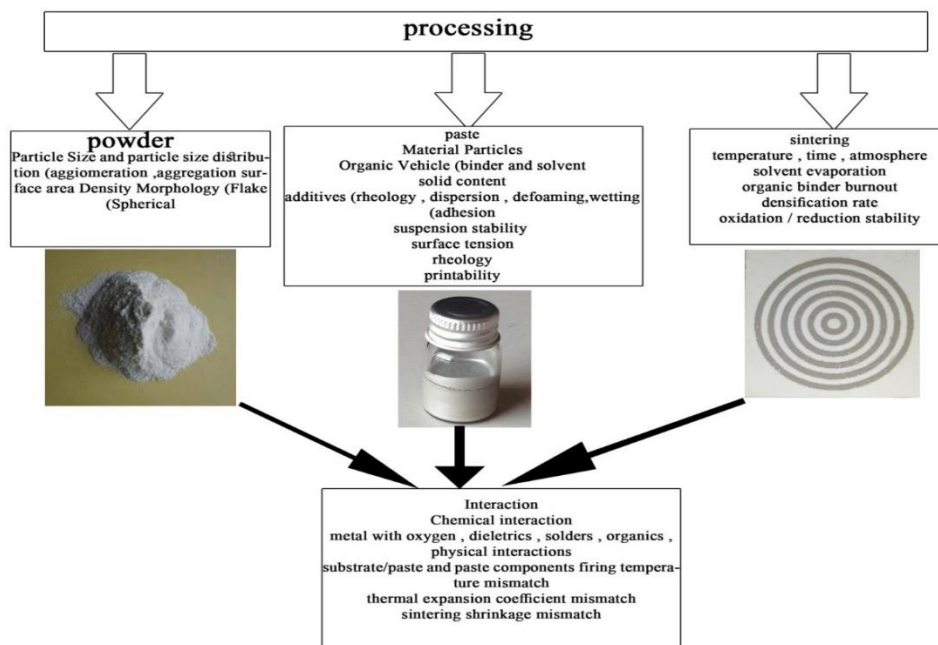

Figure1. Preparation of Conductive Silver Paste

20g silver nanoparticles were added in absolute ethanol. Then it is mixed with an organic phase (Pachin S47), followed by an Automatic pigment muller for 1h to obtain a conductive silver paste.

### Preparing conductive Powder (silver particles) with electrochemistry:

1. Make a solution of 1g silver nitrate in 50 ml water

<b>Joncryl 8055</b>	Water-based styrene acrylic copolymer	Organic binder	BASF
<b>XP53</b>	Water-based acrylic copolymer	Rheological agent	Coatex
<b>Hydropalat 216</b>	Mixture of ionic and non-ionic surfactants	Dispersing agent	Cognis
<b>Foamaster 8304</b>	Hydrocarbons and non-ionic surfactants	Anti-foaming agent	Cognis
<b>Foamaster 361</b>	Water-based fatty acids emulsion	Anti-foaming agent	Cognis
<b>Hydropalat 140</b>	Modified polysiloxane (silicone based)	Wetting agent	Cognis

Table: Screen printing pastes vehicle components

**A vehicle is required in a conductive ink formulation:**

- To ensure a stable dispersion.
- To confer fluid properties to the ink (viscosity and surface tension) and allow the ink transfer from the printing form to the substrate.
- To control the drying rate of the paste at room temperature.
- To control the line thickness and provide a homogeneous thickness.

**To grant these properties a vehicle should:**

- Be chemically non-reactive with the substrate and the metal powders to avoid the metal-organic catalysis.
- Be easily removable in the early sintering stage.
- Have a lower combustion temperature and soften faster than the point of the used mineral binder.

**1.1.1 Solvent**

Solvents with a vaporization temperature ranging from 200°C to 300°C at a pressure atmosphere (1atm), such as terpineol, ethylene glycol ethers, and esters, are generally used to manufacture screen printing conductive pastes.

**1.1.2 Organic binder**

The binder maintains the mechanical integrity of the film after the solvent evaporates and binds the different powders to each other, the organic binder should be compatible with both the metal and the substrate.



**1.1.6 Binder****1.2 Devices:**

- 1.2.1 Power supply
- 1.2.2 Magnetic stirring
- 1.2.3 Avometer
- 1.2.4 Hot air gun
- 1.2.5 Screen plate
- 1.2.6 Screen printing machine
- 1.2.7 Rubber squeegees

**1. Conductive paste formulation**

**Conductive pastes are mixture of three major components:**

- 1.1 The conductive material
- 1.2 The vehicle
- 1.3 Inorganic binder

**1.1 Conductive material (Silver Powder)**

Commercially available conductive pastes are the dispersion of relatively small conductive particles in a non-conductive resin, particles can be metallic silver, copper, or palladium. Metal particles are used in conductive pastes formulae for their high electrical conductivities, (in this study we focus only on silver conductive pastes that are being formulated and investigated).

**Vehicle components**

**The vehicle's main components were:**

- 1.2.1 Solvent with a mixture of water/ethylene glycol/glycerol to allow a slower drying rate and better leveling.
- 1.2.2 Organic binder allowing particle cohesion before sintering.
- 1.2.3 Additives providing appropriate surface tension, rheological behavior and ensuring dispersion stability.

**Vehicle components and their functions are shown on the table:**

Raw material	Nature	Function	Manufacturer
Water	Water	Solvent	----
Ethylene glycol	Ethylene glycol	Solvent	Fisher Scientific
Glycerol	Glycerol	Solvent moisturizer	Fisher Scientific
Joncryl 2136	Water-based acrylic polymer	Organic binder	BASF

Modern digital solutions are attempting to complement traditional security features by embedding radio frequency identification (RFID) tags in official paperwork and banknotes [6-8]. On the other hand, wearable RFID tags on flexible substrates have significant importance in security applications, biomedical applications, and other logistics applications [9-10]. Although traditional RFID systems based on the use of silicon RFID chips are very common and extensively used in practice, some of their limitations, such as cost and robustness, are driving many researchers towards alternative solutions, namely chipless RFID. The most promising way for RFID is to directly print on a product or package like a barcode. The chipless RFID is quite similar in function to the optical barcode, hence it is also known as RF barcode technology. The chipless RFID system is generally based on multi-resonators that perform frequency signature encoding that is signed in [11-18]. This paper presents the designs of passive RFID tags based on concentric ring resonators printed on a dielectric slab using the electrically conductive silver paste. Two different RFID tags using two different dielectric slabs are studied. The RFID technique is based on the near-field interaction of the proposed RFID tag with a planar wideband antenna. This near-field interaction introduces sharp resonances on the reflection coefficient of the wideband antenna according to the used resonators on the RFID tag. By using a thin substrate, this configuration can be quite useful for paper currency and official papers like passports to increase their security level and facilitate their tracking process. In the following section, the experimental processing of Conductive pastes is presented. In section 2, the basic configuration of the proposed RFID tag is present. section 3 presents the design of a wideband antenna and discusses the applicability of using it as a near-field reader for different RFID tags, finally, the conclusion.

## II. Experimental processing of preparing the Conductive ink

Conductive ink is a basic electronic functional material, it has attracted great research interest over the past two decades due to its wide applications in flat-panel displays, radio-frequency identification (RFID) tags, and antennas, sensors, electronic packaging, disposable electronic devices [19-23].

Conductive inks are a mixture of three major components, the conductive material, the inorganic binder, and the vehicle, these materials used for conductive inks formulation are nanoparticles or micro particles of noble metals such as gold, silver, platinum, and non-noble metal such as copper, nickel, cobalt, and iron, or nonmetallic conductive particles such as carbon, carbon nanotubes, and graphite. An inorganic binder generally composed of glass powders and other adhesion promoters may be added in some cases. A vehicle that is a mixture of organic binder, solvent, and additives to promote dispersion stability, adjust rheological behavior, and enhance stability. In this article, we focus only on silver conductive pastes.

Experimental devices and materials for manufacturing Conductive silver pastes:

### 1.1 Materials:

- 1.1.1 Distilled water
- 1.1.2 Silver nitrate
- 1.1.3 Pure Silver
- 1.1.4 Whatman 54 filter paper
- 1.1.5 Graphite rod

# Preparation of Electrically Conductive Silver Ink for Silk-Screen Printing Near Field RFID Tag for Identification Applications

Researcher. Tamer Mohamed Rabie Ali Sayed

Designer at the General Administration for Printing Banknotes - Money Printing House

- Central Bank of Egypt

[tamer24285@gmail.com](mailto:tamer24285@gmail.com)

## Abstract:

The present paper introduces the analysis and design of a near-field RFID tag for IoT in the sub-six GHz 5G frequency band, the proposed radio frequency identification technique is based on the near-field interaction between the RFID tag and a wideband antenna reader. This near-field interaction adjusts the resonances of the wideband antenna according to the used RFID tag. In addition, the far field RCS of the RFID tag is also investigated to study the relationship between the near field and the far field responses of the proposed RFID tag. The proposed RFID tag is characterized by adjustable six resonances based on concentric square rings printed on a dielectric slab. For manufacturing and experimental verification, the dielectric slab is assumed to be FR-4. However, the proposed structure can be generalized to other thin and flexible substrates like paper, plastic, and textile.

## Keywords:

Radio Frequency Identification, Multi-resonator RFID Tag, Near field Sensing.

## الملخص:

يقدم هذا البحث تحليل وتصميم لبطاقة تحديد الهوية RFID في مجال إنترنت الأشياء في نطاق تردد ٥-٦ جيجاهرتز وتعتمد تقنية تحديد الهوية بالترددات الراديوية المقترحة على تفاعل المجال القريب بين بطاقة تحديد الهوية RFID وقارئ هوائي واسع النطاق ويعمل تفاعل المجال القريب هذا على ضبط رنين هوائي النطاق العريض وفقاً لبطاقة تحديد الهوية RFID المستخدمة بالإضافة إلى ذلك يتم أيضاً فحص الإسقاط العمودي للرادار RCS للمجال البعيد لبطاقة تحديد الهوية RFID لدراسة العلاقة بين المجال القريب واستجابات المجال البعيد لبطاقة تحديد الهوية RFID المقترحة وتتميز بطاقة تحديد الهوية RFID المقترحة بعدد ٥ دوائر رنين قابلة للتعديل بناءً على حلقات مربعة متحدة المركز مطبوعة على مواد عازل لسهولة عملية التصنيع والتحقق التجريبي ويُفترض أن تكون مثل خامة ثنائي الفينيل متعدد الكلور FR-4 حيث يمكن تعميم التصميم المقترح على ركائز رقيقة ومرنة أخرى مثل الورق والبلاستيك والمنسوجات.

## الكلمات المفتاحية:

التعريف الآلي بالترددات الراديوية – بطاقات تحديد الهوية ذات دوائر الرنين المتعددة – الاستشعار بالمجال القريب

## I. Introduction

In recent years, RFID technology has been utilized for a wide range of applications, RFID is an automated contactless data-capturing technology that utilizes radio frequency waves for data transmission between a tag and the reader of an RFID system. There are three kinds of RFID systems; active RFID, passive RFID, and chipless RFID. In active RFID, every tag has a power supply and a semiconductor chip. While passive RFID, the power supply of the chip is extracted from the received wave from the reader base. Finally, chipless RFID in which the identity of each tag is encoded in its frequency response [1-5].

- 18-**H. S. Jang, W. G. Lim, K.S. Oh, S. M. Moon, and J. W. Yu. "Design of low-cost chipless system using printable chipless tag with electromagnetic code." *IEEE Microwave and Wireless Components Letters*, vol. 20, no. 11, pp. 640-642, 2010
- 19-**H. Klauk, B. D'Andrade, T.N. Jackson, in *57th Annu. Device Research Conf. Dig.* (IEEE Press, New York, 1999), p. 162
- 20-**B.K. Crone, A. Dadabalapur, R. Sarpeshkar, R.W. Filas, Y.Y. Lin, Z. Bao, *Appl. Phys. Lett.* 89, 5125 (2001)
- 21-** J.M. Hoey, M.T. Reich, A. Halvorsen, D. Vaselaar, K. Braaten, M. Maassel, I.S. Akhatov, O. Ghandour, P. Drzaic, D.L. Schulz, *IEEE Trans. Adv. Packag.* 32, 809 (2009)
- 22-**B.K. Crone, A. Dadabalapur, A. Gelperin, L. Torsi, H.E. Katz, A.J. Lovinger, *Appl. Phys. Lett.* 78, 2229 (2001)
- 23-**M. Mantysalo, P. Mansikkamaki, in *NIP23 and Digital Fabrication (2007)*, p. 813
- 24-**R. FADDOUL, Optimization of printing processes dedicated to mass production of microelectronic components, THESIS To obtain the rank of DOCTOR OF THE UNIVERSITY OF GRENOBLE, 2012.